

**Please read this manual
carefully before use!**

Owner's Manual



Robotic lawn mower

KS 22RLM

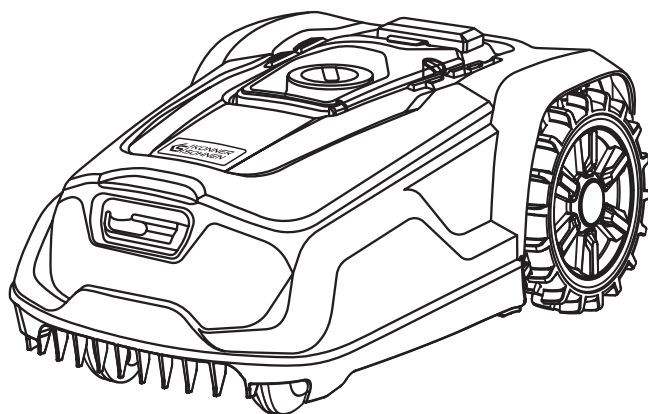



Thank you for opting for **Könnner & Söhnen®** products. This manual contains a brief description of safety, setup and use. More information can be found on the official importer's website in the support section: **konner-sohnen.com/manuals**

You can also go to the support section and download the manual by scanning the QR code or on the website of the official importer of **Könnner & Söhnen®** at **www.konner-sohnen.com**



*Please, read this manual
carefully before use!*

The manufacturer of **Könnner & Söhnen®** products reserves the right to make changes that may not be reflected in this manual, namely:

- The manufacturer reserves the right to make changes in the product design, configuration and construction.
- The images and drawings in this manual are for reference only and may differ from the actual components and inscriptions on the products.

Contact information that you are free to use in case of any problems can be found at the end of this manual. All information in this manual is correct to the best of our knowledge and belief at the date of its publication. The current list of service centers can be found on the official importer's website at **www.konner-sohnen.com**



ATTENTION – DANGER!



Failure to follow the recommendations marked with this sign may lead to serious injury or death of the operator or third parties.



IMPORTANT!



Useful information while operating the machine.

GENERAL SAFETY INSTRUCTIONS

1



ATTENTION – DANGER!



This device may cause serious injury if used improperly. To avoid personal injury and damage to property, read and comply with the following safety instructions and familiarise yourself with all control elements.



IMPORTANT!



Read the instruction manual carefully. Keep the instruction manual for subsequent consultation.

PREPARATION

- This device is not intended for use by children, individuals with limited physical, sensory or mental capabilities, those with insufficient experience or knowledge or individuals who are not familiar with the instructions. Children should be supervised to ensure that they do not play with the device. Cleaning and maintenance must not be carried out by children.
- Never let children or persons who are not familiar with these instructions use the machine. Local regulations may restrict the age of the operator.
- The operator or user is responsible for any accidents or personal injury and/or material damage to third parties or their property.
- Check the terrain on which the device will be used and remove any stones, sticks, wires or other foreign objects.

- Always perform a visual inspection of the device before using it. Do not use the device if its safety equipment, parts of the cutting unit or bolts are missing, worn or damaged. Damaged tools and bolts must only be replaced as a set to prevent imbalance.
- Take care when using devices with several cutting tools since the movement of one blade can lead to rotation of the other blades.
- Only use spare parts and accessories which are supplied and recommended by the manufacturer. Using externally produced parts results in the immediate loss of the warranty claim.
- Ensure correct installation of the automatic perimeter guard system according to the instructions.

USING THE DEVICE



ATTENTION – DANGER!



Do not bring your feet or hands into the vicinity of rotating parts (or beneath them) when working. Risk of injury!



WARNING!



Observe noise protection rules and other local regulations.

- The robotic mower is intended for automatic lawn care. Its use for other purposes is not permitted and may be dangerous or result in damage to the machine.
- Never leave the machine unattended if you know that pets, children or other people are nearby. Children must be kept away from the machine and mowing area during mowing operation. Dogs and other pets must be kept away from the machine and mowing area during mowing operation
- Avoid operating the machine when the grass is wet.
- If foreign bodies enter the cutting tools, or if the machine generates unusual noises or vibrates unusually, immediately turn off the power supply (STOP) and allow the machine to come to a standstill. Disconnect the machine from the mains supply and perform the following steps before switching the machine on again and operating it:
 - Check the machine for damage;
 - replace or repair all damaged parts;
 - check whether there are any loose parts and tighten as necessary.
- Switch off the device, wait for the blades to come to a stop and remove the battery from the device.
 - before a blockage is removed;
 - before checking, cleaning or working on the machine;
 - to check the machine for damage after a foreign object has entered;
 - for an immediate check if the machine starts to vibrate abnormally.
- Switch the motor on as directed and only if your feet are a safe distance away from the cutting tools.
- Switch the device on with care in accordance with these instructions. Ensure your feet are at a sufficient distance from the rotating blades.
- The device must not be lifted or transported while the motor is running.
- Do not work with a damaged or incomplete device or one which has been converted without the permission of the manufacturer.

MAINTENANCE AND STORAGE

- Before starting cleaning, repair or maintenance operations, activate the disabling device and park the robotic mower on firm and level ground.
- Disconnect the mains plug of the power supply unit before performing any work on the docking station and the perimeter wire.
- Allow the robotic mower to cool down for approx. 5 minutes before performing any maintenance operations.
- Make sure that all nuts, bolts and screws are properly tightened, and that the device is in safe working order.
- Inspect the lawn mower for any damage.

- Do not try to repair the device by yourself unless you have professional training. All work not mentioned in these instructions may only be performed by authorised service representatives commissioned by us.
- Only use accessories or attachments approved for this machine by or technically identical parts. Otherwise, there may be a risk of accidents resulting in personal injury or damage to the machine.
- The complete machine must be cleaned carefully at regular intervals. Never spray water (particularly using high-pressure cleaners) onto motor components, seals, electric components or bearing points. This may result in damage and expensive repairs.
- Do not clean the machine under running water (e.g. using a garden hose). Do not use aggressive cleaning agents. These can damage plastics and metals, impairing the safe operation of your machine.
- Store the device in a dry place and out of reach of children. Ensure that the machine is protected from unauthorised use (e.g. by children). Store the machine in good operational condition. Thoroughly clean the machine before storage (e.g. winter break). Allow the machine to cool for approx. 5 minutes before storing it in an enclosed space.
- Handle your device with care. Keep the tools sharpened and clean in order to be able to work better and safer. Follow the maintenance instructions.
- Wear safety gloves when replacing the cutting equipment.
- Replace worn or damaged parts in the interests of safety. When setting up the blades, take care that your fingers do not become caught between the rotating blades and stationary parts of the machine.
- Ensure that only replacement cutting tools approved by the manufacturer are used.

ELECTRICAL SAFETY

- Make sure that the mains voltage matches the details on the type plate.
- This robotic lawnmower is equipped with several safety devices to ensure safe operation and prevent misuse.
- Keep the power cord away from the cutting tool when working. The cutting blades can damage the power cord and lead to contact with live parts.
- Do not use the power cord to pull the plug from the outlet. Protect the power cord from heat, oil and sharp edges.
- Switch the device off and pull the mains plug out of the outlet if the power cord is damaged. If the cord of this device is damaged, it must be replaced by the manufacturer or their customer service or by a similarly qualified person in order to avoid hazards.
- Do not connect a damaged power cord to the power supply. Do not touch a damaged power cord as long as it is connected to the power supply. A damaged power cord can result in voltage-carrying parts being touched.

SPECIAL SAFETY INSTRUCTIONS FOR BATTERY-POWERED DEVICES

- Ensure that the device is switched off before inserting the rechargeable battery. Inserting a battery into a power tool that is switched on can lead to accidents.
- After pressing the red STOP button on the top of the robotic lawnmower, the machine stops immediately. The cutting blade stops after a few seconds and a corresponding message appears on the display. While the message is active, the robotic lawnmower cannot be controlled and is safe.
- Do not expose the battery to direct sunlight for long periods and do not place it on a radiator. Heat damages the battery and there is a risk of explosion.
- If warm, allow the battery to cool before charging.
- Do not open the battery and avoid mechanical damage to the battery. There is a risk of a short circuit and vapours may leak out, causing irritation to the respiratory tract. Seek fresh air and also seek medical assistance in case of complaints.
- Do not use non-rechargeable batteries. The device could become damaged.
- Store the battery out of the reach of children.
- Only use or store the battery at temperatures from -10°C to max. +50°C.

- Protect the battery from rain and moisture - do not immerse it in liquid. Do not expose the battery to microwaves or high pressure.
- Battery may leak due to improper use - avoid contact! In case of accidental contact, flush the area with water. Consult a doctor if the liquid gets into your eyes. Leaking battery fluid can cause skin irritation and burns. Do not insert any objects into the battery vents.

CORRECT HANDLING OF THE CHARGER

- The battery is intended exclusively for fixed installation in robotic mower. It is optimally protected there and is charged when the robotic mower is in the docking station. No other charger must be used. The use of an unsuitable charger can result in danger due to electric shock, overheating or escaping corrosive battery fluid.
- Before each use, check the charger, cable and plug, and have repairs carried out by qualified personnel using only original spare parts. Do not use the charger if defective and do not open it yourself. This ensures the safety of the device is not adversely affected.
- Make sure that the mains voltage matches the details on the charger's type plate. Risk of electric shock.
- Disconnect the charger from the mains supply before closing or opening connections to the power tool. This ensures the rechargeable battery and charger are not damaged.
- Avoid mechanical damage to the charger. This can lead to internal short circuits.
- If the cord of this device is damaged, it must be replaced by the manufacturer or their customer service or by a similarly qualified person in order to avoid hazards.

RESIDUAL RISKS

There will always be residual risks even if you operate this power tool according to the instructions. The following hazards may occur in connection with the type and design of this power tool:

- Cut injuries if suitable gloves are not worn.



ATTENTION – DANGER!







During operation, this power tool produces an electromagnetic field. Under certain circumstances, this field may negatively affect active or passive medical implants.











In order to reduce the danger of serious or fatal injuries, users who wear medical implants must consult their doctor and the manufacturer of the implant before operating the machine.

GRAPHICAL SYMBOLS

2

SYMBOLS ON THE DEVICE

	Caution!
	Read the instruction manual carefully.
	Risk of injury due to ejected parts.
	Keep nearby persons away from the lawn mower.
	Caution - sharp cutting blades! Keep away from feet and hands. Risk of injury! Switch off the motor before carrying out adjustments or cleaning work.

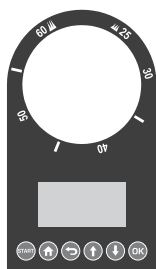

	Do not sit on the device.
	Do not use the device when it is raining, do not cut wet grass.
	Danger of electric shock!
	Caution! Risk of injury from moving blades.
	DANGER - rotating cutting blades.
	Keep nearby persons and children away from the lawn mower.
	Caution! The lawn mower blades will continue to move.
	Sound power level L _{WA} indicated in dB.
	Electrical devices must not be disposed of with domestic waste.
	220 mm Cutting circle.
	Protection class III.







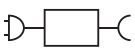

Cutting height adjustment





Display control

SYMBOLS ON THE POWER ADAPTER

	Caution!
	Read the instruction manual carefully.
	Removable supply unit.

	Device fuse.
	Short-circuit proof, closed safety transformer.
	Switched-mode power supply.
	Protection class II.
	Electrical devices must not be disposed of with domestic waste.
	Producer.

GRAPHICAL SYMBOLS ON THE CHARGING STATION

	LED flashing green: Boundary wire damaged or incorrectly connected.
	LED illuminated red: Battery charging.
	LED illuminated green: Battery charged.
	Electrical devices must not be disposed of with domestic waste.
	Operating range indicator.

MAIN OVERVIEW

3

See the annex on page 104.

- | | | |
|--------------------|-----------------------------|-------------------------------|
| 1. Cover | 14. Power adapter | 27. Contact socket – |
| 2. Rotary wheel | 15. Mains plug | 28. LED |
| 3. START button | 16. Charging plug | 29. Groove |
| 4. HOUSE button | 17. Charging station | 30. Charging prongs |
| 5. Back button | 18. Charging station bumper | 31. Operating range indicator |
| 6. Arrow button | 19. Screw | 32. Battery compartment |
| 7. OK button | 20. Blade | 33. Battery |
| 8. Carrying handle | 21. Baseplate | 34. Blade bolt |
| 9. Stop button | 22. Charging unit | |
| 10. Display | 23. Cover | |
| 11. Boundary wire | 24. Bushing | |
| 12. Fixing nails | 25. Charging socket | |
| 13. Hooks | 26. Contact socket + | |

**IMPORTANT!**

Manufacturer reserves the right to make changes and/or improvements in design, components set and technical attributes without notice and without incurring obligation. The pictures in this manual are schematical and may not match the parameters of original product.

SCOPE OF DELIVERY**4**

Carefully remove the device from the packaging and check whether all the parts listed below are present and complete:

- Lawn mower
- 170 m boundary wire
- Charging station + 4 screws
- Power adapter
- Battery
- 6 fixing nails
- 230 hooks
- Instruction manual

DESCRIPTION OF FUNCTIONS**5**

The lawn mower has a rotating cutting tool parallel to the cutting plane. It is equipped with a high-performance electric motor, a robust plastic housing and a safety switch. In addition, the device has infinite height adjustment and smooth-running wheels.

The lawn mower can optionally be connected and controlled with Tuya Smart App. Please refer to the descriptions below for information on how the operating elements work.



iOS



Android

**SPECIFICATIONS****6**

Robotic lawn mower	KS 22RLM
Motor voltage	20V
Drive speed	1,2 km/h
No-load rotation speed	3100 rpm
Cutting circle	220 mm
Cutting height	25-65 mm
Slope/incline/gradient	47% (25°)
Blade	3 with double-sided blades,
Max. work area	900 m ²
Mowing time per battery charge (4 Ah)	approx. 70 min*
Recommended operating time (hrs) per day* 900 m ²	16 hours
Sound power level (Lwa) guaranteed/measured	66 dB (A)/61,1 dB(A), Kwa = 1,88 dB
Gross dimensions (L×W×H)	470×280×360 mm
Gross/Net weight	18,0/9,0 kg
Protection type	IPX4

*Depending on the type of grass, growing conditions, humidity and flatness of the lawn area.

Power adapter	
Input voltage	230 V, 50 Hz; 1,5 A
Output voltage	22 V; 2,5 A
Protection class	II
Protection type	IP65
Max. outdoor temperature	50 °C

Charging station	
Input voltage	22 V, 2,5 A
Output voltage	21 V, 2,4 A
Protection class	IPX4
Weight	2,3 kg
Charging time for 21V 2Ah	approx. 60 min

INITIAL START-UP

7



IMPORTANT!



Regularly check the lawn area for rocks, branches, wires and objects that may damage the device and the blades.

ASSEMBLING AND POSITIONING THE CHARGING STATION

1. Place the charging unit (22) with the two lugs first into the baseplate (21) of the charging station.
2. Press the charging unit (22) down so that it is firmly seated in the baseplate.
3. Fix the charging unit (22) from below to the baseplate (21) with the four enclosed screws (19).
4. Select a flat position near an outlet for the charging station (17) with at least 2 m of space in front and 1 m behind.

Once you have laid and connected the boundary wire, you still need to fix the charging station. Please refer to chapter "Fixing the charging station".



WARNING!



Make sure that the charging station (17) is positioned an adequate distance away from ponds, pools and steps.



IMPORTANT!



We recommend installing a roof for the charging station (17) to protect it from weather damage.

INSTALLING THE BOUNDARY WIRE

Before starting up the lawn mower, the boundary wire (11) must be placed around the lawn area to be covered by the automatic lawn mower. You can do this as follows:

- Mark out the lawn area with the hooks (13).
- Bury the boundary wire (11) in the ground (max. depth of 5 cm).



WARNING!



The lawn mower crosses over the boundary wire by about 20 - 30 cm before it turns around and searches for a new path. Install the boundary wire accordingly to prevent damage.

For the initial installation, we recommend marking out the boundary wire (11) with the hooks (13) in case corrections need to be made at a later date.

- The lawn area must be bordered as a single enclosed area (see figure 1).

- Any parallel boundary wires (11) installed at a distance of at least 10 cm are identified as an obstacle by the lawn mower and are evaded (see figure 2).
- Any parallel boundary wires (11) at a distance of 5 mm or less are not detected by the lawn mower and are passed over.
- Avoid creating corners with a 90° angle. Instead, split these into two 45° angles (see figure 3).
- The lawn mower's sensors are able to detect and evade stationary and solid obstacles (walls, garden furniture, etc.) larger than 100 mm. Protect sensitive obstacles (e.g. flowerbeds) on the lawn area with the boundary wire (11).
- Keep a distance of at least 1 m between bordered obstacles. Border obstacles that do not meet this minimum distance as a single obstacle (see figure 2).



WARNING!



Make sure that the boundary wire (11) does not intersect at any point. This can lead to faults and failures in the lawn mower's operation.

TREES

The lawn mower detects trees as a normal obstacle. However, protruding roots may damage the underside/blades (20). We recommend using the boundary wire (11) to also border trees..

ROCKS

- Remove small rocks (lower than 100 mm) from the lawn area. These may damage the device and the blades (20).
- The lawn mower detects rocks (taller than 100 mm) as normal obstacles. We recommend using the boundary wire (11) to also border rocks.

SLOPES/GRADIENTS

The lawn mower is able to traverse uphill slopes/gradients up to max. 25° (47%).
At a distance of 1 m from the boundary wire, the slope/gradient should not exceed 5.7° (10%).



WARNING!



Make sure that a distance of at least 30 cm is maintained between the boundary wire (11) and an obstacle on an uphill gradient and at least 40 cm on a downhill gradient.

PONDS/POOLS

Ponds and pools should be bordered by the boundary wire (11) where possible or designed so that the lawn mower cannot enter the water. This may seriously damage the device's electronics.

PATHS/ROADS

The lawn mower can easily cross paths and roads at ground level.

If there are height differences between the lawn area and path/road, border off the path/road with a safety distance of approx. 40 cm.

NARROW PASSAGES

Narrow passages on the bordered lawn area should be at least 1.2 m wide and no more than 8 m long (see figure 4).



NOTE



The width of 1.2 m refers to the distance of the boundary wire. The boundary wire is crossed by the lawn mower 0.2 m on both sides when mowing.

CONNECTING THE CHARGING STATION TO THE POWER ADAPTER

1. Connect the power adapter (14) to the charging station (17) via the charging plug (16) and the charging socket (25).
2. Screw the bushing (24) around the joint to protect it from moisture.

CONNECTING THE BOUNDARY WIRE TO THE CHARGING STATION

1. Strip approx. 10-15 mm of both ends of the boundary wire (11) using cable strippers.
 2. Fold the cover (23) upwards.
 3. Connect the wire end of the boundary wire (11) that runs away from the front and surrounds the lawn to be mown to the contact socket (27) marked (-).
 4. Pass the other end of the boundary wire (11) through the groove (29) under the charging station (17).
 5. Connect this end of the wire to the contact socket (26) marked (+).
 6. Connect the mains plug (15) to the power supply.
 7. Check the LED (28) on the charging station.
- If the LED (28) lights up green, the boundary wire (11) is connected to the charging station (17) correctly.

**NOTE****Allow extra space of 0.5 to 1 m for corrections when installing the boundary wire (11).****WARNING!****Do not place the "protruding" remains of the boundary wire together. This can lead to faults and failures in the lawn mower's operation.****FIXING THE CHARGING STATION**

- Secure the charging station and the charging station bumper (18) with the fixing nails (12).
The charging station bumper (18) is fastened to the side of the charging station outside the restricted lawn area.
The operating range indicator (31) on the charging station must be located within the restricted lawn area.

INSERTING/REPLACING THE BATTERY**WARNING!****When replacing the battery: Switch off the device and wait for the blades to come to a stop. There is a risk of personal injury.****ATTENTION – DANGER!****There is a risk of injury from leaking battery fluid if the battery is damaged! In case of contact with eyes or skin, rinse the affected sites with water or a neutralizer and seek medical attention.**

1. Turn the lawn mower over.
2. Open the battery compartment (32) by removing the 4 screws on the under side of the device.
3. If necessary, remove the empty battery (33).
4. Insert a charged battery.
5. Close the battery compartment (32) again.

OPERATION**8****SWITCHING ON THE LAWN MOWER**

1. Press and hold the START button (3) for approx. 3 seconds until the display (10) lights up.
 2. Set the desired language. Select with the arrow buttons (6) and confirm the selection with the OK button (7).
 3. Set the date and time with the arrow buttons (6).
- Confirm the selection with the OK button (7). The individual positions can be navigated with the OK button (7) (skip the right).

**NOTE****The correct date and time setting is required to ensure the correct function of the operating time settings.**

4. Enter the 4-digit PIN (factory setting "1111"). For information on which buttons translate into PIN entry and how, see chapter "Setting".



NOTE



Change the factory-set password after initial commissioning, see chapter "Changing the PIN".

5. Press the OK button (7) to enter the main menu.
The lawn mower is now in standby mode.

SETTING THE LANGUAGE

1. If necessary, open the cover (1).
2. Unlock the display (10) with the 4-digit PIN (factory setting "1111").
3. Press the OK button (7) to enter the main menu.
4. Use the arrow buttons (6) to select „Settings“.
5. Confirm the selection with the OK button (7).
6. Use the arrow buttons (6) to select "Language".
7. Confirm the selection with the OK button (7).
8. Use the arrow buttons (6) to select the desired language.
9. Confirm the selection with the OK button (7).
10. Return to the main menu with the back button (5).

SWITCHING ON AND OFF

Switching on the lawn mower

1. Press and hold the START button (3) for approx. 3 seconds until the display (10) lights up.
2. Enter the 4-digit PIN (factory setting "1111"). For information on which buttons translate into PIN entry and how, see chapter "Setting".
3. Press the OK button (7) to enter the main menu.
The lawn mower is now in standby mode.



NOTE



If the lawn mower is in standby or charge mode, press the START button (3) once to start mowing. The lawn mower will not start until the cover (1) is closed.

If you have entered the wrong PIN:

Wait about 3 seconds or press the OK button (7) to be able to enter the PIN again.

If you enter an incorrect PIN three times in a row, the screen is locked for 15 seconds. For each additional incorrect PIN, the blocking time is doubled.

SWITCHING OFF THE LAWN MOWER

Press and hold the START button (3) for about 3 seconds.

The lawn mower stops if:

- the STOP button (9) is pressed;
- the START button (3) is pressed for 3 seconds;
- the cover (1) is raised;
- it loses the boundary wire signal and does not find it again within 5 minutes it crosses the boundary wire when mowing;
- it gets stuck between obstacles and needs more than 10 seconds to find a way out;
- it is raised.

MOWING

1. Open the cover (1).
2. Unlock the display (10) with the 4-digit PIN (factory setting "1111").

When the lawn mower is in the charging station and charging:

3. Press the START button (3) once.
- If the battery charge level is more than 70 %, the display shows "Close the cover to start". Close the cover (1) and the mower will start mowing automatically.

- If the battery charge level is less than 70 %, the display shows “Low battery” after 2 seconds. The lawn mower charges until the battery charge level is 90 % and then starts mowing automatically.

When the lawn mower is in standby mode:

3. Press the START button (3) once.

- If the battery charge level is more than 30 %, the display shows “Close the cover to start”. Close the cover (1) and the mower will start mowing automatically.
- If the battery charge level is less than 30 %, the display shows “Low battery” after 2 seconds. The lawn mower moves to the charging station.



NOTE



Depending on the nature of the grass (height, thickness), the robotic lawn mower adjusts its mowing speed to ensure a good result.

BACK TO THE CHARGING STATION

When the unit is in standby mode, press and hold the HOME button (4) for about 3 seconds. The display (1 0) shows “Close cover to start”. Close the cover (1) and the mower moves to the charging station. It then begins to charge there.

SETTINGS

9

The lawn mower has the following setting options that you can make via the control panel if you want to change the factory settings.

Button on the control panel	Name	Number for PIN entry	Function
	HOUSE button (4)	1	Press in standby mode to make the robot return to the charging station
	Arrow button (6)	2	Move selection/cursor up, in menu interface Increase digit when setting parameters
	Arrow button (6)	3	Move selection/cursor down, in menu interface Reduce digit when setting parameters
	OK button (7)	4	Confirm setting Call up PIN entry interface after an error condition has ended Call up next menu Confirmation to move from main menu to next menu level
	Back button (5)		Back to previous menu Cancel next job

MENUS ON THE DISPLAY

Main menu	Menu level 2	Menu level 3
Spot mode		
Setting	Language	
	Date&time	
	Rain mode	
	Work time	
	Set WiFi	
	Change PIN	

Main menu	Menu level 2	Menu level 3
Setting	Information	Error log
		Work log
		Device information
	Factory set	
	Version check	
Schedule		
Secondary areas		

EXPLANATION OF THE (STATUS) MESSAGES ON THE DISPLAY

Text in control panel	Explanation
Standby	Lawn mower is in standby mode, there are no error messages
Input PIN	Prompt to enter the PIN
Charging	Lawn mower charges
Mowing	Lawn mower mows
Auto mowing	Lawn mower mows automatically
Spot mode	Lawn mower mows a defined area
Fix point mowing finished	Mowing completed in "spot mode"
Returning	Lawn mower on the way back to the charging station
Paused	Lawn mower in pause state triggered by: – Pressing the STOP button – Pressing the "Pause" button on the APP
Emergency stop	The STOP button (9) has been pressed
Charge to work	Lawn mower charges
Updating	Perform firmware necessary/in progress
Low battery, charge to work	The charge level of the battery does not meet the minimum requirements at the start of work: 70 % for automatic mowing 30 % for fixed point mowing (spot mode)
Raining now, returning	The rain sensor has been activated
Close cover to start	Request to close the cover (1)
Charge to work paused	Charging was interrupted (e.g. manually or due to a power failure)
Work interrupted, please retry	Automatic mowing was interrupted (e.g. STOP button (9) was pressed, cover (1) was opened)
Place inside the boundary and retry	Request to place the lawn mower inside the boundary wire
Continue working?	Press the OK button (7) to continue the work or press the Back button (5)
Time set wrong	Correct times
Charge to work paused	Charging process was interrupted, cause to be checked on site
Close cover to start	Close cover (1)
Current work was stopped	Work process was interrupted, check cause on site
Low battery voltage	The charge level of the battery does not meet the minimum requirements at the start of work: 70 % for automatic mowing 30 % for fixed point mowing (spot mode)
Low battery, charge to work	Place the lawn mower in the charging station or to wait for the charging process to finish or lawn mower returns to the charging station independently
Low battery voltage, return to station	
No loop signal	
No signal, please setup the loop first	Check correct installation of the boundary line and correct if necessary, place the lawn mower inside the boundary and restart it
Loop signal lost	
Mower was locked! waiting...	Wait until the currently running process is completed
Wrong PIN, kindly retry	Enter the PIN again
Place inside the boundary and retry	
Mower outside	Place the lawn mower inside the boundary and restart it

Text in control panel	Explanation
Please reboot to start the firmware update	Restart lawn mower
Work interrupted, please retry	
Rain sensor activated	Rain sensor is activated
Mower in the station	Mower in the station
Mower is not in the station	Mower is not in the station, if necessary, place the lawn mower in the station
Press ‚START‘ key to start	Press the START button (3)
Duration at least 30 mins	Indication of the time needed
Searching for signal...	Lawn mower searches for its signal
Copy file, please wait	Please wait for the copying process
Please turn it off	Switch off lawn mower
Update fail	If necessary, carry out the update procedure again
Error	See chapter "Reading out the work and error log"
Cutting motor stall	See chapter "Removing blockages"; Check blades for foreign bodies/defects; If necessary, contact manufacturer (see "Service Centre")
Left motor stall	
Please replace the battery	Replace battery
Battery abnormal	
Battery damaged	
Battery temperature too low (discharge)	Cancel charging process
Battery voltage high	Battery voltage too high
Battery High temp	Battery has a high temperature
High charge current	Cancel charging process, check input current
High charge voltage	Cancel charging process, check input voltage
High temp	Cancel charging process
Mower lifted	Lawn mower was lifted
Mower overturned	Set lawn mower upright and restart
Mower trapped	Clear the lawn mower and restart
Mower tilted	Set lawn mower upright and restart
Motor over temperature	Switch off the lawn mower and let it cool down
Motor error	Contact manufacturer (see «Service Centre»)
Emsensor disconnect	
Hall sensor failure	
Hardware error	
Ladung abnormal	
Charging abnormal	
Battery discharge error	
Inertial measurement unit (IMU) Error	
Motor disconnect	
Motor hall error	
Motor overcurrent	
Motor stall	
Right motor stall	
Rain sensor failure	
Loop sensor failure	

SPOT MODE / FIXED POINT MOWING

This function allows you to mow lawns that are otherwise covered by seating furniture, playground equipment or similar.

1. Place the mower on the target area of the lawn.

2. If necessary, open the cover (1).
3. Unlock the display (10) with the 4-digit PIN (factory setting "1111").
4. Press the OK button (7) to enter the main menu.
5. Select "Spot mode" with the arrow buttons (6).

The display shows "Close the cover to start".

6. Close the cover (1) and the mower starts mowing with the fixed point.

The lawn mower mows in an anti-clockwise spiral direction and switches to "Automatic mowing" after a mowing radius of 1 m or 3.5 minutes of mowing.

If the mower encounters an obstacle, the mower stops, the display indicates that mowing has stopped and the mower switches to standby mode.

When the lawn mower hits the boundary wire (11), it continues mowing in the opposite spiral direction.

If the mower is outside the boundary wire (11) or on the charging station and you select "Spot mode", the display shows "Place inside the boundary and retry". Set the mower down inside the boundary wire (11) and next to the charging station and restart "Spot mode".



NOTE



If the battery charge level is less than 30%, the display shows "Low battery voltage" after 2 seconds. Charge the lawn mower before you can start mowing with the fixed point.

SETTING THE DATE AND TIME

1. If necessary, open the cover (1).
2. Unlock the display (10) with the 4-digit PIN (factory setting "1111").
3. Press the OK button (7) to enter the main menu.
4. Use the arrow buttons (6) to select "Settings".
5. Confirm the selection with the OK button (7).
6. Use the arrow buttons (6) to select "Date&time".
7. Confirm the selection with the OK button (7).
8. Change the date and time with the arrow buttons (6). The individual positions can be navigated with the OK button (7) (skip the right).

The correct date and time setting is required to ensure the correct function of the operating time settings.

SETTING THE RAIN SENSOR



ATTENTION – DANGER!



Never operate the lawn mower during storms and make sure to disconnect the charging station from the mains.

If the rain sensor is switched on, the lawn mower returns to the charging station when it rains.

1. If necessary, open the cover (1).
2. Unlock the display (10) with the 4-digit PIN (factory setting "1111").
3. Press the OK button (7) to enter the main menu.
4. Use the arrow buttons (6) to select "Setting".
5. Confirm the selection with the OK button (7).
6. Use the arrow buttons (6) to select "Rain mode".
7. Confirm the selection with the OK button (7).
8. To deactivate the rain sensor, select "Disable" and confirm the selection with the OK button (7). To activate the rain sensor, select "Enable" and confirm the selection with the OK button (7).

Select a time in minutes when the lawn mower should start operating again after the rain.

Decide also whether the lawn mower should make up for the break in operating time caused by the rain.

Confirm each selection with the OK button (7).

9. Return to the main menu with the back button (5).



NOTE



We advise against having the lawn mower operate while it is raining.

SETTING THE OPERATING TIMES

1. If necessary, open the cover (1).
2. Unlock the display (10) with the 4-digit PIN (factory setting "1111").
3. Press the OK button (7) to enter the main menu.
4. Use the arrow buttons (6) to select "Setting".
5. Confirm the selection with the OK button (7).
6. Use the arrow buttons (6) to select "Work time".
7. Confirm the selection with the OK button (7).
8. Select the desired operating time with the arrow buttons. You set the operating time in full hours per day.
9. Confirm the selection with the OK button (7).
10. Return to the main menu with the back button (5).

When the set operating time per day is reached, the lawn mower automatically returns to the charging station. An extension of the operating time during rain breaks can be set directly via the lawn mower, see chapter "Setting the rain sensor" or via the Tuya Smart App: Settings > Rain Sensor.

CONNECTING THE LAWN MOWER TO THE WLAN

1. If necessary, open the cover (1).
 2. Unlock the display (10) with the 4-digit PIN (factory setting "1111").
 3. Press the OK button (7) to enter the main menu.
 4. Use the arrow buttons (6) to select "Setting".
 5. Confirm the selection with the OK button (7).
 6. Use the arrow buttons (6) to select "Set WiFi".
 7. Use your smartphone to connect to the lawn mower via the Tuya Smart App.
- See chapter "Connecting the device with the Tuya Smart App".

CHANGING THE PIN

1. If necessary, open the cover (1).
2. Unlock the display (10) with the 4-digit PIN (factory setting "1111").
3. Press the OK button (7) to enter the main menu.
4. Use the arrow buttons (6) to select "Setting".
5. Confirm the selection with the OK button (7).
6. Use the arrow buttons (6) to select "Change PIN".
7. Confirm the selection with the OK button (7).
8. Enter the old 4-digit PIN. If you have entered the PIN incorrectly, use the back button (5) to return to the pin entry.
9. Now enter a new PIN.
10. Confirm the new PIN by entering it again. If you have entered the PIN incorrectly, return to the pin entry with the back button (5) and repeat steps 8 and 9.
11. You can recognise a successful change when "Success!" appears on the display (10). Return to the main menu with the back button (5).

SETTING/DELETING A SCHEDULE

10

SETTING A SCHEDULE

1. If necessary, open the cover (1).
2. Unlock the display (10) with the 4-digit PIN (factory setting "1111").
3. Press the OK button (7) to enter the main menu.
4. Use the arrow buttons (6) to select "Schedule".

5. Select the day you want to set (Mon, Tue, Wed, Thu, Fri, Sat, Sun) with the arrow buttons (6).
6. Press the OK button to enter the day setting.
7. Select the start and end time with the arrow buttons (6). Two mowing periods can be set per day.
8. Press the OK button (7) to confirm and the selection returns to the left of the day. If you only want to set a mowing period, return to the day or to the main menu with the back button (5).
9. Repeat steps 5.-8. to select the schedule period for each day of the week.
10. Press the OK button (7) to confirm the result of this setting.

DELETING A SCHEDULE

1. Move the selection with the arrow buttons (6) to "Alie" (top left).
2. Press and hold the back button (5) to delete the entire schedule for the week.

SETTING SECONDARY AREAS

1. If necessary, open the cover (1).
2. Unlock the display (10) with the 4-digit PIN (factory setting "1111").
3. Press the OK button (7) to enter the main menu.
4. Use the arrow buttons (6) to select "Secondary areas".
5. Press the OK button to select a secondary area (Areas). Select the starting distance "Distance (dst)m" and the ratio "Percent(pct)%" of the area to be mowed with the arrow buttons (6) and press the OK button to confirm. After the selection, you automatically return to the overview of the secondary areas.
6. Repeat step 5 to complete the setting of each secondary area (Areas).
7. Press the OK button (7) to confirm the result of the setting.

The lawn mower travels the distance "Distance (dst)m" specified by you along the boundary wire (1–500 metres) and then starts mowing.

Under "Percent (pct)%" you specify the ratio of what percentage of the total area within the boundary wire should be mown. The sum of the "Percent (pct)%" indication of the 5 secondary areas (Areas) must be less than/equal to 100 %.

RESTORING FACTORY SETTINGS

The lawn mower can be reset to factory settings here.

1. If necessary, open the cover (1).
2. Unlock the display (10) with the 4-digit PIN (factory setting "1111").
3. Press the OK button (7) to enter the main menu.
4. Use the arrow buttons (6) to select "Setting".
5. Confirm the selection with the OK button (7).
6. Use the arrow buttons (6) to select "Factory set".
7. Confirm the selection with the OK button (7).

The lawn mower switches off and resets itself to the factory setting.

Resetting the lawn mower to factory settings does not delete the personal data saved when connecting to the Tuya Smart App. To delete this data, proceed as described in the chapter "Disconnecting the device and deleting data from the app".

READING OUT THE WORK AND ERROR LOG

1. If necessary, open the cover (1).
2. Unlock the display (10) with the 4-digit PIN (factory setting "1111").
3. Press the OK button (7) to enter the main menu.
4. Use the arrow buttons (6) to select "Setting".
5. Use the arrow buttons (6) to select "Information".
6. Use the arrow buttons (6) to select "Error log" or "Work log". The error and work log can be read out here.
7. Press the back button (5) to return to the main menu.

CHECKING THE FIRMWARE UPGRADE

1. If necessary, open the cover (1).

2. Unlock the display (10) with the 4-digit PIN (factory setting "1111").
3. Press the OK button (7) to enter the main menu.
4. Use the arrow buttons (6) to select "Setting".
5. Use the arrow buttons (6) to select "Version check".

A check is made to see if a more recent firmware is available. If yes, it will be downloaded and installed automatically.

6. Press the back button (5) to return to the main menu.

CHARGING

11



ATTENTION – DANGER!



Do not expose the battery to extreme conditions such as heat and shocks. There is a risk of injury from leaking battery fluid! In case of contact with eyes or skin, rinse the affected sites with water or a neutralising agent and seek medical attention.

- Charge the battery before using it for the first time.
- If the operating time is considerably shortened despite charging, this shows that the rechargeable battery is depleted and must be replaced. Only use an original battery purchased from customer service.
- Always comply with the latest safety information, as well as the regulations and information relating to environmental protection.
- Defects resulting from improper handling are not covered by the guarantee.

CHARGING THE BATTERY

The lawn mower automatically returns to the charging station when it has a low charge status. To do so, the lawn mower locates the nearest boundary wire and follows this in a clockwise direction.

You can also place the lawn mower in the charging station yourself.



ATTENTION – DANGER!



Risk of injury! Press the STOP button (9) before picking up the mower!

After the battery is fully charged, the charging process stops and the lawn mower switches to standby mode.

GRAPHICAL SYMBOLS ON THE CHARGING STATION

	LED flashing green: Boundary wire damaged or incorrectly connected.
	LED illuminated red: Battery charging.
	LED illuminated green: Battery charged.
	LED not illuminated: Charging station not connected to power.

CHECKING THE CHARGE LEVEL OF THE BATTERY

You can check the charge status of the lawn mower on the LCD display at any time.

1. If necessary, open the cover (1).
2. Unlock the display (10) with the 4-digit PIN (factory setting «1111»).
3. The charge status is now shown by the battery symbol at the top right.
4. Press the START button (3) and close the cover (1) again. The lawn mower resumes its previously interrupted activity.

It is also possible to read the charge level without unlocking the display, but it is easier when the display is unlocked.

WORKING INSTRUCTIONS

12

Regular mowing stimulates the grass to an increased leaf formation, while at the same time killing weeds. As a result, the lawn becomes denser after each mowing and an evenly resilient lawn is created.

The first cut takes place roughly in April when the grass is about 7 - 8 cm high. During the main growing season, the lawn is mowed at least once a week.

SETTING THE CUTTING HEIGHT



ATTENTION – DANGER!



Switch off the device and wait for the blades to come to a stop. There is a risk of personal injury.

1. Open the cover (1).
2. Set the rotary wheel (2) to the desired cutting height.
3. Close the cover (1) again.

The device can be adjusted in 15 steps to a cutting height between 25 - 65 mm.

The correct cutting height is between 30 and 45 mm for an ornamental lawn and about 30 to 65 mm for a utility lawn.

A high cutting height should be selected for the first cuts in the season.

MANUALLY INTERRUPTING/ STARTING THE OPERATING CYCLE

Interrupting operation

Press the STOP button (9) to stop the mower during operation.

Starting/resuming operation

1. Open the cover (1).
2. Confirm the selection with the OK button (7).
3. Unlock the display (10) with the 4-digit PIN (factory setting «1111»).
4. Press the start button (3).
5. Close the cover (1) again.



The lawn mower starts the set operating cycle or resumes its previous activity without interruption.

CONNECTING THE DEVICE WITH THE TUYA SMART APP

13

1. Open the cover (1).
 2. Unlock the display (10) with the 4-digit PIN (factory setting «1111»).
 3. Press the OK button (7) to enter the main menu.
 4. Use the arrow buttons (6) to select “Settings”.
 5. Confirm the selection with the OK button (7).
 6. Use the arrow buttons (6) to select “Set Wi-Fi”.
 7. Enable Bluetooth on your smartphone.
 8. Open the Tuya Smart App.
- From here there are options **1**, **2** and **3** to connect the device..

1 If this is the device you wish to connect to the app:

9. On the  tab, select the option “Add device”. The app scans the area for available devices and indicates if available devices have been found. If this is not the case, read on if possible **3**.
10. If you select “Go to add”, the available devices are displayed in a list.
11. Select the device by setting the check mark . Select only one device at a time. If there are other check marks for other devices, clear the check marks by pressing them.

12. Now press the **+**, that has the same colour as the set check mark.

13. Select your WLAN and enter the corresponding password.

14. Confirm the successful connection with "Finish".

The device is now listed in the  tab and can be selected.

2 If you have already connected other devices to the app:

9. On the  tab, select the **+** in the upper right. The app scans the area for available devices and indicates if available devices have been found. If this is not the case, read on if possible 3.

10. Proceed as with 1 from point 10.

3 If a list of available devices is not automatically suggested to you:

If the device is not suggested automatically, follow these steps:

9. On the  tab, select the **+** in the upper right.

10. Select "Other" in the bar on the left.

11. Select "Other 2".

12. Confirm that the display is flashing rapidly. The app now searches for available devices and suggests them to you.

13. Select the desired device by pressing the **+** to add it to the app.

14. First confirm with "Next", then with "Finish".



IMPORTANT!



Upgrading the firmware can change the features of the app.

ACTIVATING BLUETOOTH



IMPORTANT!



Bluetooth is only required to connect the device with the Tuya Smart App.

After the device is connected to the Tuya Smart app, the Bluetooth switches off and only switches on again when the device is reset to factory settings.

1. If necessary, open the cover (1).

2. Unlock the display (10) with the 4-digit PIN (factory setting "1111").

3. Press the OK button (7) to enter the main menu.

4. Use the arrow buttons (6) to select "Setting".

5. Confirm the selection with the OK button (7).

6. Use the arrow buttons (6) to select "Set Wi-Fi".

7. Confirm the selection with the OK button (7).

This is required for the initial connection with the Tuya Smart App, after which there is a WLAN connection and the Bluetooth function of the mower is inactive.

FEATURES OF THE APP

If you select a lawn mower, this will take you to the overview page.

Press the button in the left circle and hold your thumb on the display to swipe the **START**  selection up and down.

To select the individual menus via the **START**  position.

Schedule

Here you can set two operating periods for the lawn mower for each day of the week. The lawn mower must be in standby mode so that you can make settings here.

1. Select the desired day.

2. For the Time period define a Start time and an End time.

3. Save the schedule at the top right at "Save".

The schedule can be reset in the practise menu on the right via "reset".

Secondary areas

Here you can set up to 5 secondary areas. The lawn mower must be in standby mode so that you can make settings here.



1. Select a secondary area.
2. Set the distance to the entry point. The lawn mower travels along the boundary wire for the distance you have specified and then starts mowing.
3. Set a percentage of area. The area percentage indicates what percentage of the total area within the boundary wire is to be mown. The sum of the area percentages of the 5 secondary areas must be less than/ equal to 100 %.
4. Confirm with "Save".

If you do not want to divide the area to be mown into secondary areas, select:

Distance to the entry point: 1 m Percentage of area: 100 %

Control

Here you can:

- View the mode the mower is currently in
- Read the battery capacity in percent;
- Start or pause automatic mowing .
- Start spot mowing via the Fixed point  selection if the lawn mower is currently in standby mode. This function allows you to mow lawns that are otherwise covered by seating furniture, playground equipment or similar.
- Via the Station  selection, let the lawn mower move to the charging station.

Error log

Here you can read out the error and time of the error.

Work log

Here you can read out the operating times of the lawn mower.

Settings

Here you can:

- Set the total operating time per day under Operating hours
- Set a device password (PIN) set und change
- Activate and deactivate the rain sensor and set a time when the lawn mower should start operating again after the rain. You can also specify whether the lawn mower should make up for the pause in operating time caused by the rain.



NOTE



Weadvise against having the lawn mower operate while it is raining.

Settings

If you select the , icon again, you can assign a new image to the lawn mower under "Symbol", you can rename the lawn mower under "Name" or assign it a "Location".

"Device information" - can be called up under this menu item.

"Tap to run and automate" allows you to run automations you have saved.

"Share device" allows you to grant other members of the same household access to the lawn mower via the Tuya Smart App.

"Offline Message", when activated, sends you a notification when the App loses connection to the lawn mower.



"Create group" allows you to create device groups.

"FAQ" answers frequently asked questions.

“**Check for firmware upgrade**” checks if the firmware is up to date and enables an upgrade if a newer version is available.

“**Remove device**” deletes the lawn mower from your device list in the app. Also read “Disconnecting the device and deleting data from the app”.

DISCONNECTING THE DEVICE AND DELETING DATA FROM THE APP

1. In the  tab, select the device that you want to remove and whose data you want to delete.
2. Select the  icon in the top right.
3. Select “Remove device”.
4. To delete the data, select “Disconnect and delete data”.

If you just want to disconnect the device without deleting the data, select “Disconnect”.

PROBLEMS WITH THE APP?

FAQ

1. Select the device you have questions about from the device list.
2. Select the  icon in the top right.
3. Under “Other” select the option “FAQ” (Frequently Asked Questions).

CLEANING / MAINTENANCE / STORAGE

14



WARNING!



Have any work that is not described in these instructions performed by an authorised customer service centre. Only use original parts.



ATTENTION – DANGER!



Before any maintenance or cleaning work, switch off the device and wait for the blades to come to a standstill.

Wear gloves when handling the blades.

GENERAL CLEANING AND MAINTENANCE WORK



ATTENTION – DANGER!



Never spray down the lawn mower with water. There is a risk of electric shock.

- Keep the device clean. Use a brush or cloth for cleaning, but do not use any aggressive cleaning agents or solvents.
- Oil the wheels from time to time.
- Check the covers and protective devices for damage and correct fit. Replace these if necessary.

TURNING/REPLACING THE BLADES

The lawn mower is equipped with reversible blades. If the blades are blunt on one side, they can be turned over. If the blades are damaged or show signs of imbalance, they need to be replaced (see “Spare parts/ accessories”).

1. Turn the device over.
2. Remove blade bolts (34) on the underside of the device.

Turning the blades

3. Turn the blades (20) over.
4. Refasten blades with the blade bolts (34).

Replacing the blades

3. Remove the old blades (20).
4. Refasten the new blades (20) with the blade bolts (34).

REMOVING BLOCKAGES



Wear safety gloves. There is a risk of injury.

1. Turn the lawn mower over.
2. Open the battery compartment (32) by removing the 4 screws on the underside of the device.
3. Remove the battery (33).
4. Remove the blockage.
5. Re-position the battery (33).
6. Close the battery compartment (32).

STORAGE

- Store the device in a dry place, out of reach of children.
- Do not enclose the device in nylon sacks as this may cause moisture to form.

We are not liable for damage caused by our devices if this is caused by improper repair, the use of non-original parts or incorrect use.

STORAGE OVER WINTER

- Clean the device prior to storage (see «Cleaning and maintenance»).
- Only store the battery when it is in a partially-charged state. The charge status should amount to 40-60% during a lengthy storage period.
- Check the battery charge status approximately every 3 months during a prolonged storage period and recharge if necessary.
- Disconnect the charging station from the boundary wire.
- Insulate the contacts of the boundary wire with adhesive tape.

If you are starting the device after an extended storage period, clean the battery contacts on the device and the charging prongs (E 30) on the charging station with a brass brush to prevent charging problems.

TRANSPORT

15

A carrying handle (8) for transporting the device is located on the rear of the lawn mower.



ATTENTION – DANGER!



Always carry the lawn mower with the blades (20) pointing away from your body. Risk of injury!

DISPOSAL/ENVIRONMENTAL PROTECTION

16

Remove the battery from the device and recycle the device, battery, accessories and packaging in an environmentally-friendly manner.



Electrical devices do not belong in domestic waste.



Do not throw batteries into domestic waste, fire (risk of explosion) or water. Damaged batteries can harm the environment and your health if poisonous fumes or liquids escape.

Directive 2012/19/EU on waste electrical and electronic equipment: Used electrical devices must be collected separately for disposal and recycled in an environmentally sound manner.

Depending on the implementation in national law.

Problem	Possible cause	Remedy
Machine does not start	Rechargeable battery not inserted	Insert rechargeable battery (see "Replacing the rechargeable battery")
	Cover (1) is open	Close cover (1)
	Defective motor	Send the device in to the Service Centre for repair
	Grass too long	Pre-mow the lawn area if necessary. Set higher cutting height
Motor switches off	Blockage by foreign body	Remove foreign body
Lawn mower moves, but does not cut	Blades blunt or defective	Replace blades (see "Turning/replacing blades")
	Cutting motor defective	Contact manufacturer (see "Service Centre")
Output not satisfactory or motor is difficult to operate	Cutting height too low	Set higher cutting height
	Blades (20) blunt	Sharpen or replace blades
	Blade area blocked	Clean device
	Blades (20) incorrectly mounted	Install blades correctly
Abnormal sounds, clattering or vibrations	Blade bolts (34) loose	Tighten blade bolts
	Blades (20) damaged	Replace blade
Lawn mower moves out of the boundary	Routing error: 90° corners can lead to signal loss	Take corners widely or at a 45° angle

The international manufacturer warranty is 1 year. The warranty period starts from the date of purchase. In cases when warranty period is longer than 1 year according to local legislation please contact your local dealer. The Seller which sells the product is responsible for granting the warranty. Please contact the Seller for warranty. Within the warranty period, if the product fails because of defects in the production process, it will be exchanged on the same product or repaired.

All faults caused by the manufacturer during the warranty period will be eliminated free of charge. Warranty repair is carried out only if you have a fully completed warranty card, the Buyer's signature of acceptance of the warranty terms, as well as a document supporting the purchase (cash receipt, sales slip or invoice). In the absence thereof, as well as in the event of errors or corrections not authenticated by the seller's seal or illegible inscriptions in the warranty card or tear-off coupon, no warranty repair is carried out, no objections to quality are accepted and the warranty card is withdrawn by the service center as invalid. The device is accepted for repair clean and full.

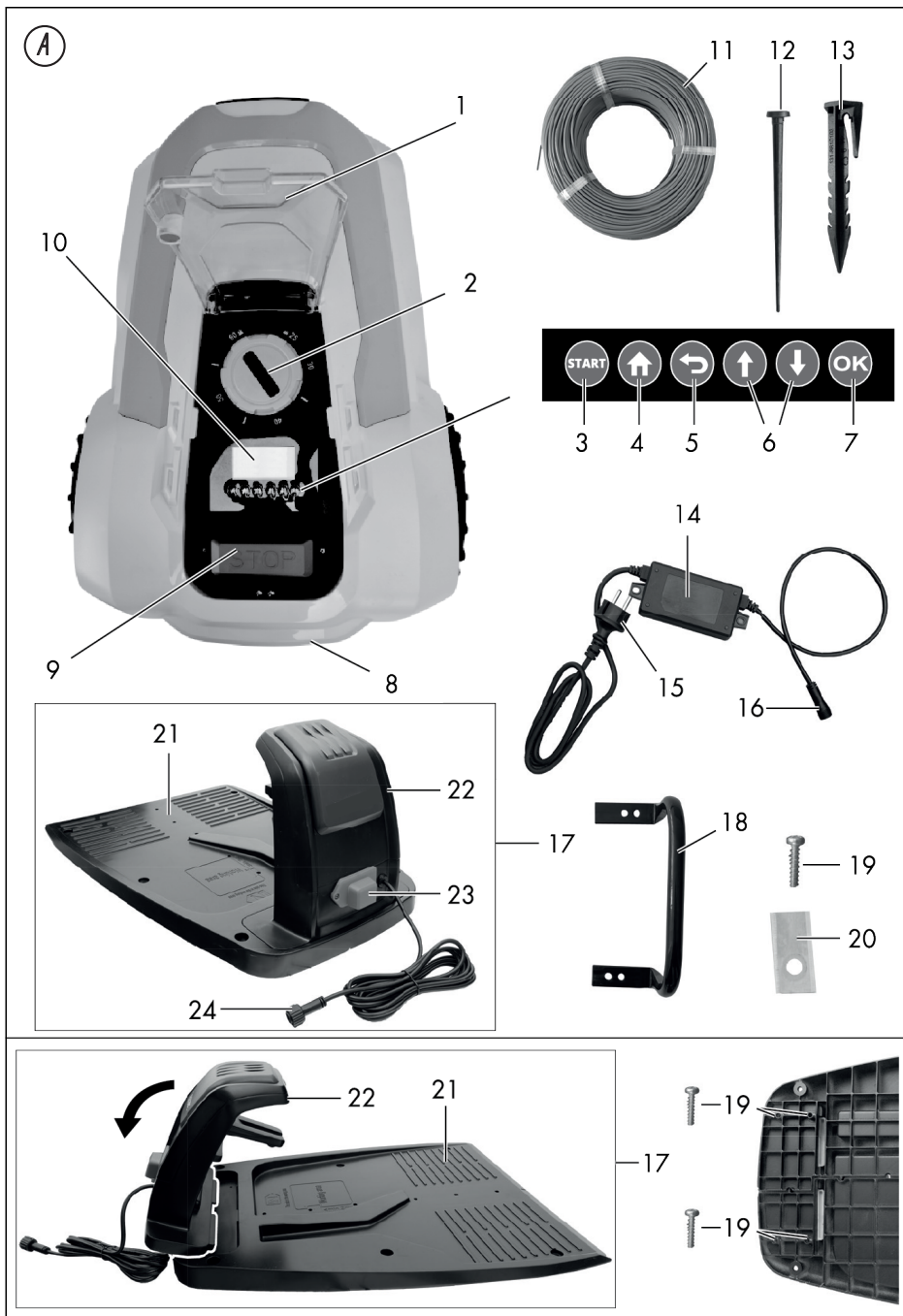

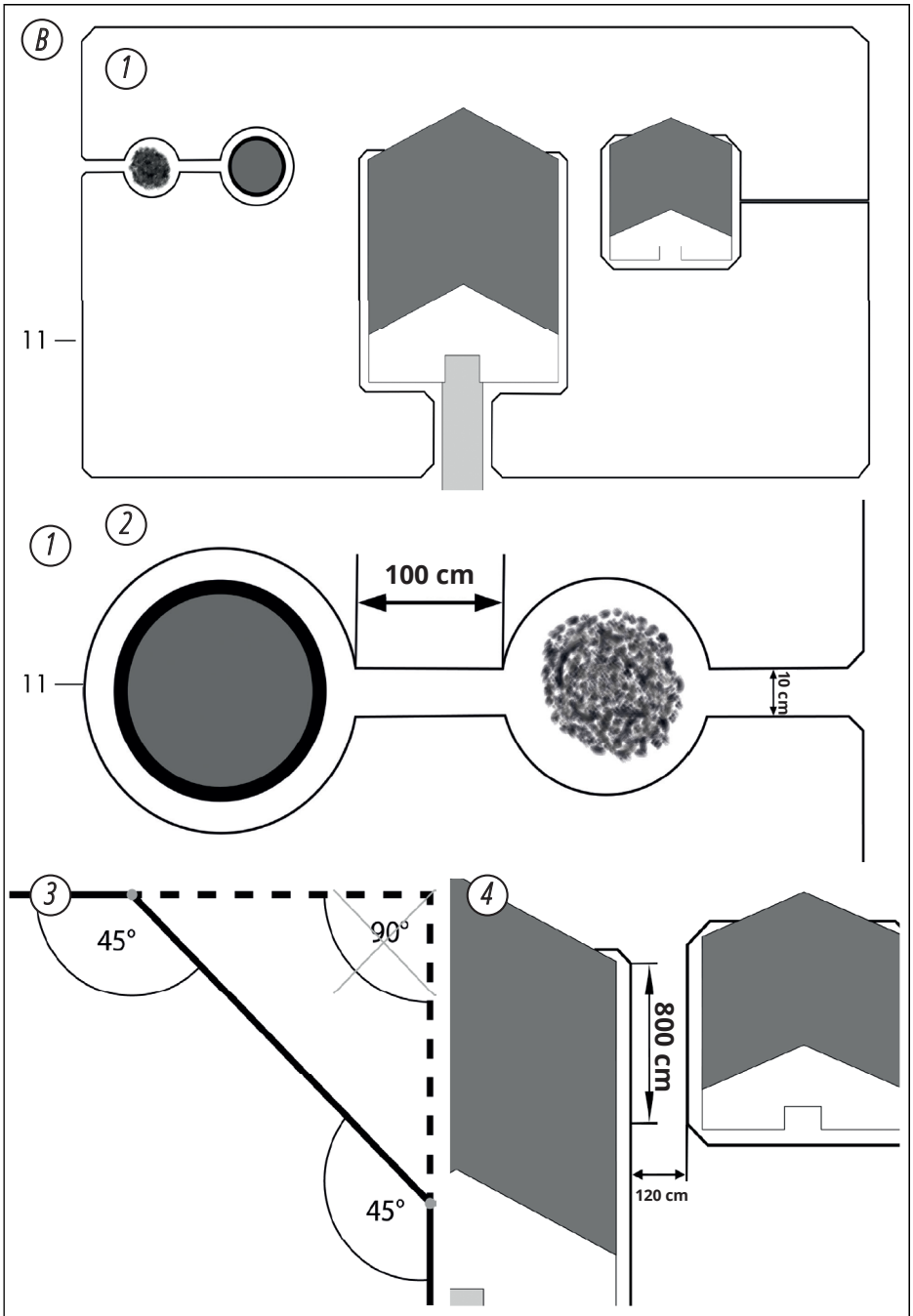

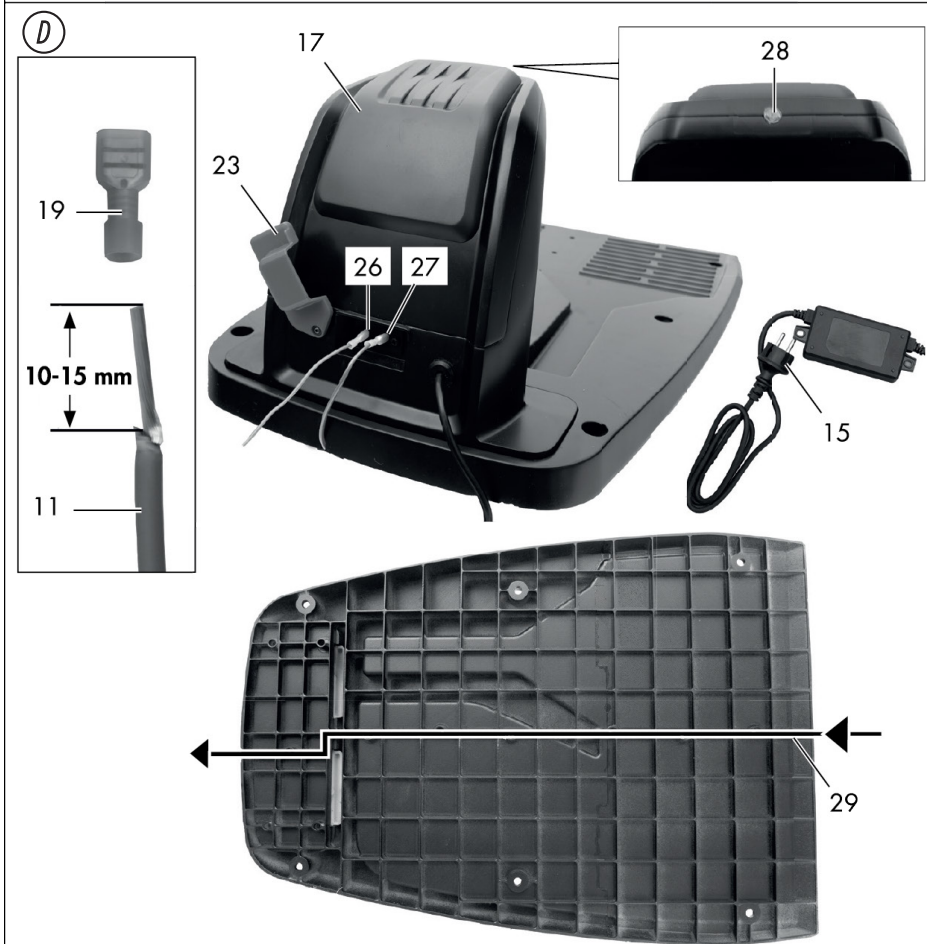
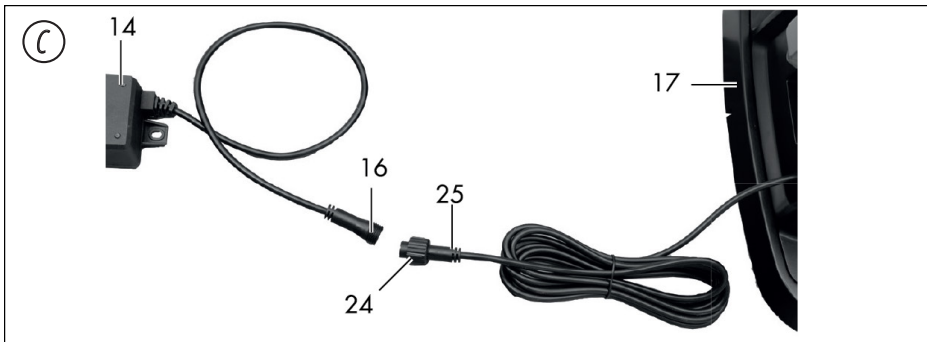

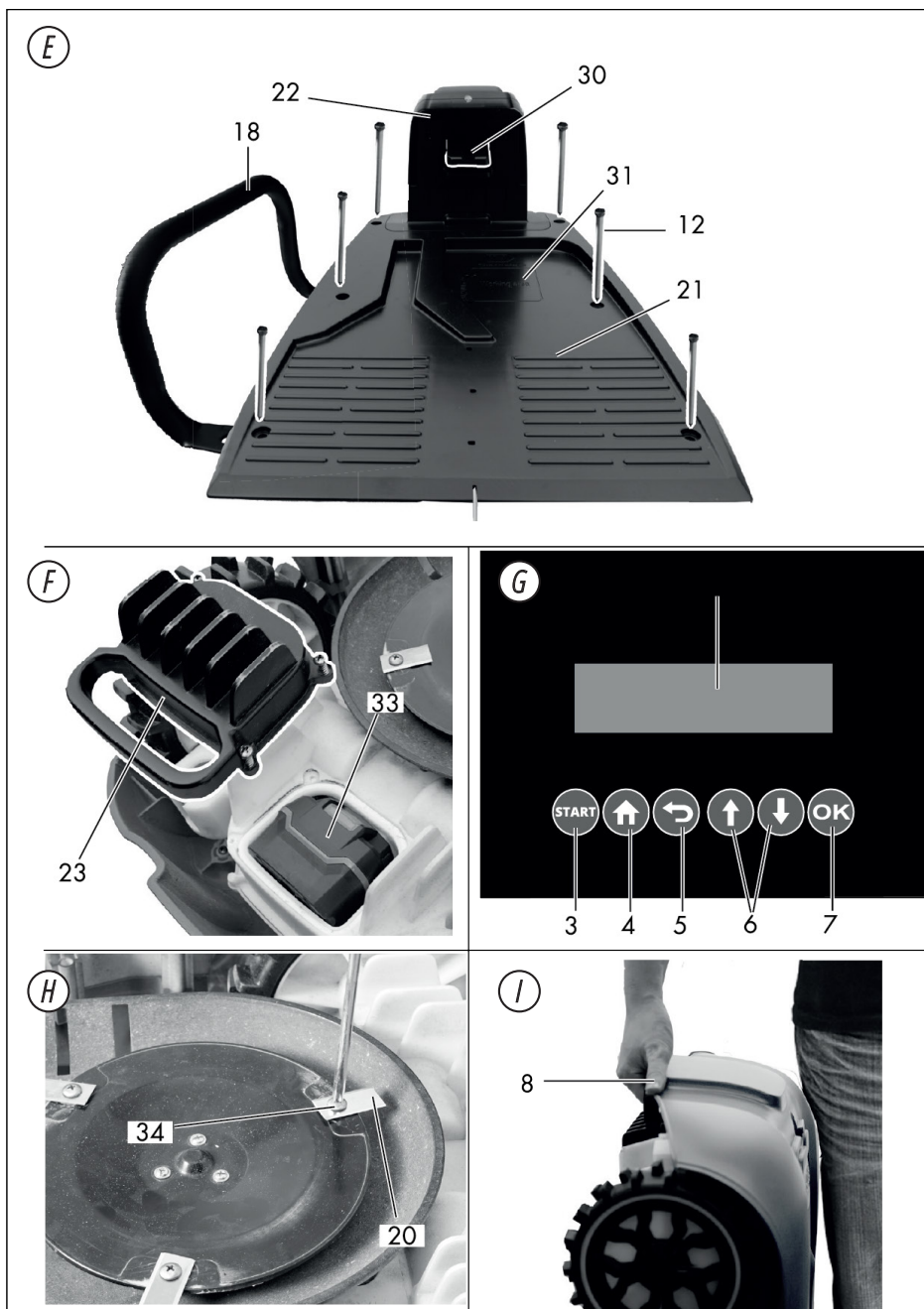



EC Declaration of Conformity

Nr. 187

The following products have been tested by us with the listed standards and found in compliance with the European Community Directive 2014/30/EU relating to electromagnetic compatibility, Directive 2006/42/EC relating to machinery.

Manufacturer: DIMAX INTERNATIONAL GmbH
Address: Flinger Broich 203, 40235 Duesseldorf, Germany
Product: Robotic lawn mower "Könner & Söhnen"
Type / Model: KS 22RLM

The statement is based on a single evaluation of above mentioned products. It does not imply an assessment of the whole production and does not permit the use of the test lab. logo. The manufacturer should ensure that all product in series production are in conformity with the product sample detailed in this report. The applicant should hold the whole technical report at disposal of the competent all the right.

Applied EC Directives: 2006/42/EC Machinery Directive
2014/30/EU Electromagnetic compatibility Directive (EMC)

Applied Standards: EN 60335-1:2012/A15:2021
EN 50636-2-107:2015/A3:2021
AfPS GS 2019:01 PAK

2000/14/EC_2005/88/EC Annex VI

For model KS 22RLM Noise measured Lwa = 64 dB (A), guaranteed Lwa = 66 dB (A)



Issued Date: 2024-02-08
Place of issue: Duesseldorf
Director: Fomin P.

P. Fomin

DIMAX
International GmbH
Flinger Broich 203 40235 Düsseldorf
USt-ID DE296177274
koenner-soehnen.com

We DIMAX INTERNATIONAL GmbH hereby declare that specified above conforms covering European Parliament and Council Directives, 2006/42/EC of 17 May 2006 Machinery Directive, Electromagnetic compatibility Directive (EMC) 2014/30/EC of 26 February 2014. The CE mark above can be used under the responsibility of manufacturer. After completion of an EC declaration of Conformity and compliance with all relevant EC directives.

CONTACTS

Deutschland:

DIMAX International GmbH
Flinger Broich 203 -FortunaPark-
40235 Düsseldorf, Deutschland
www.koenner-soehnen.com

Ihre Bestellungen

orders@dimaxgroup.de

Kundendienst, technische Fragen und Unterstützung

support@dimaxgroup.de

Garantie, Reparatur und Service

service@dimaxgroup.de

Sonstiges

info@dimaxgroup.de

Polska:

DIMAX International
Poland Sp.z o.o.

Polska, Warszawska,
306B 05-082 Stare Babice,
info.pl@dimaxgroup.de

Україна:

ТОВ «Техно Трейд КС»,
вул. Електротехнічна 47, 02222,
м. Київ, Україна

sales@ks-power.com.ua
